



PDF PATTERNS

McCall's®

M8169

FACE COVER

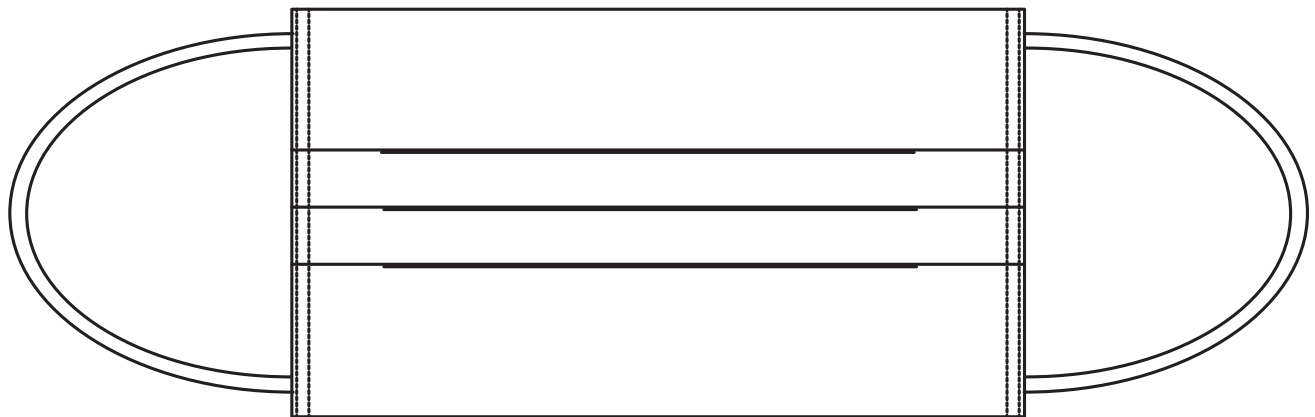

THINGS YOU'LL NEED

> 1/2 Yard (0.5m) of 1/8"(3mm) - 1/4"(6mm) wide Elastic.

SUGGESTED FABRICS

> Tightly Woven Cottons

CUTTING INFO

2 PIECES OF FABRIC 7 3/4" x 7 1/2" (19.5cm x 19cm)

FACE COVER

- 1** Cut two pieces of elastic each measuring 7"(18cm) long. On **OUTSIDE**, pin ends of elastic to one face cover section, centering at large circles. Baste.

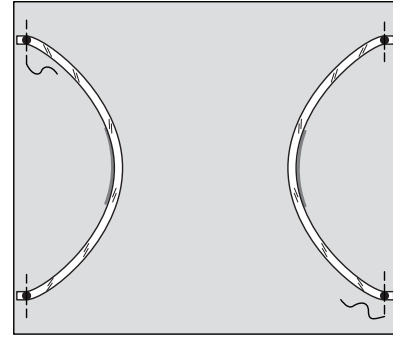

- 2** Pin face cover sections together. Stitch outer edges in a 1/4"(6mm) seam, leaving an opening.

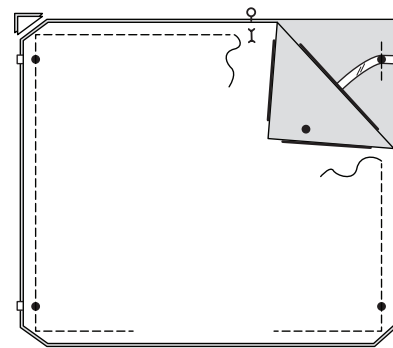

- 3** Turn cover **RIGHT** side out, sew opening. Stitch close to finished edges.

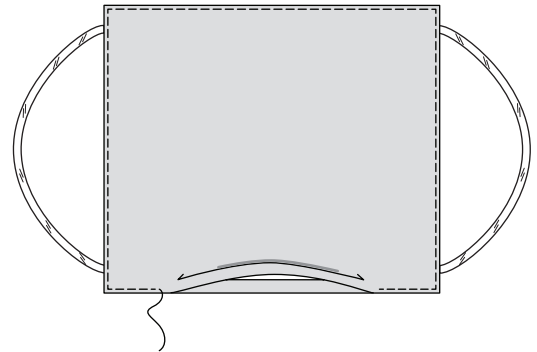

- 4** To make pleats, on **OUTSIDE**, fold along solid lines through all thicknesses.

Bring folds to broken lines. Baste 1/2"(1.3cm) from finished edges.

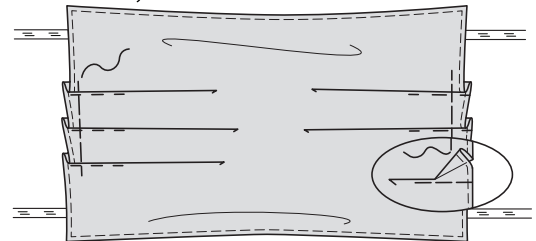

- 5** On **OUTSIDE**, stitch along basting. Stitch again 1/8"(3mm) away from first stitching.

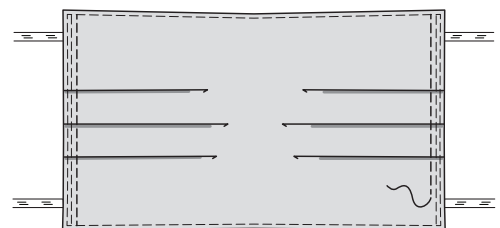



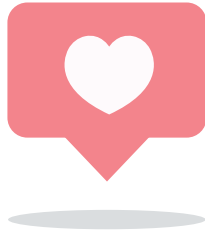

Congrats!

You've completed your sewing adventure!

SHARE YOUR look!



Post your pattern and tag us at
@McCALLPATTERNCOMPANY and use #MCCALLSPATTERNS
for a chance to be featured on our social media!

Look for more McCall's PDF patterns at **McCALLPATTERN.COM**

 1-800-255-2762

Copyright © 2020 CSS Industries, Inc. All Rights Reserved.
Sold for individual home use only and not for commercial or manufacturing purposes.